



ROGER'S WINDOWS
GLASS & DOORS

Vinyl

Closets

Windows

Patio Doors

Arch Dual Glaze

French Swing Doors

 Rogers Windows Glass & Doors

 RogerWindows.la

 10464 Alondra Blvd, Bellflower, CA 90706

 (562) 866-5600

 8512 S. Comptom ave, Los Angeles, CA 90001

 (323) 584-9026

www.rogerswindows.la



Roger's Windows was founded in 1994. Roger started of working for a different company and by 1996 he proceeded to open up his own location in the City of Los Angeles, CA. Roger has over 20 years of experience in the vinyl window and door industry.

Our windows move to the home efficient. We also offer a good warranty on our windows and doors. We offer energy, saving windows which help your home stay much cooler.

Our main goal is to manufacture high quality windows for homeowners and construction companies. Over the years we've manufactured several different vinyl products, such as, different type of styled windows and patio doors.

1 CHOOSE YOUR WINDOW STYLE & FRAME TYPE:

Frame options:

At Roger's Windows we offer different vinyl frames to meet the needs of our customers. We have frames for new construction jobs or for remodel jobs. All of these are easy to install and made with precision cuts. We also sell a variety of different TremCo sealants to eliminate additional stops! Standard window & door color is White, custom color vinyl coatings are also available for an additional cost.

These are typically used to replace existing aluminum windows. The retrofit fin will cover the outside view of the aluminum frame that will be inside the house or building. Vinyl trim or wood molding is needed to cover the inside view of the existing aluminum frame. These are not included. Premium Windows does however, offer vinyl trim for additional cost.



Retrofit

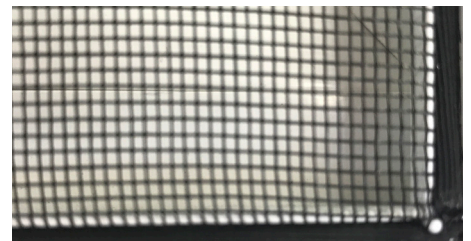

Screens are included with all window purchases and vary from different windows. They are easy to remove and can be replaced if damaged.

Block Frames are commonly used to replace existing wood windows. It is a non-finned frame that can be used as new or retrofit installation in a block (concrete) wall or as an existing wood window replacement frame.

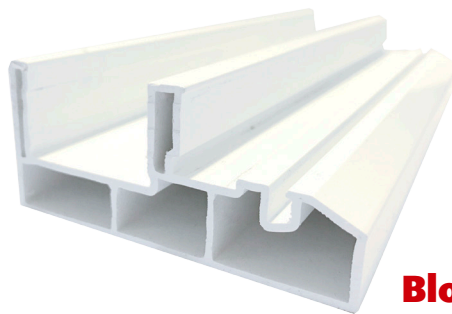

Block



Weep holes are located at the bottom of the sash frame & allow water to escape. We assemble these with a vinyl flap to keep insects and debris out.

Used on new construction or remodeling where stucco will be applied after window installation. These are installed by nailing or screwing the window frame directly onto the wood frame of the house or building at the 1" fin (also known as a set back).



Nail-On

SLIDING WINDOWS

Sliding windows open horizontally and do not take up much space in the home. This makes them ideal for walkways, porches, patios or other places where you wouldn't want a window to protrude. Our state-of-the-art design ensures they will add style as well as functionality to your home.

Horizontal sliding windows glide open with little effort & are faster to open than crank-style awning or casement windows. The sliding sash can be easily removed to clean the exterior glass from inside your home.

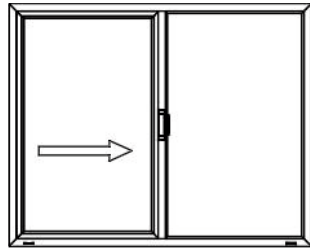

XO-OX
Sliding from Left to Right
(Look from Outside)

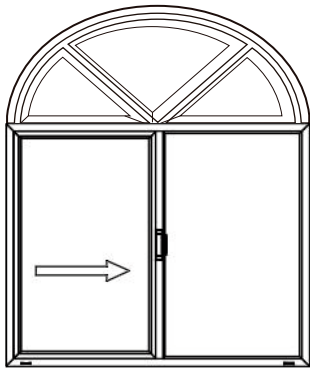

XO-OX
Sliding from Left to Right
(Look from Outside)

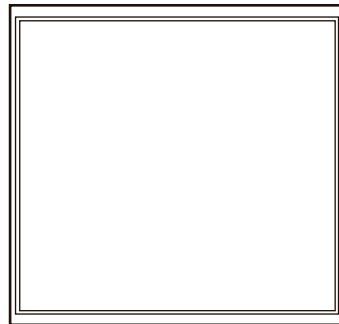

Picture Window
(Look from Outside)

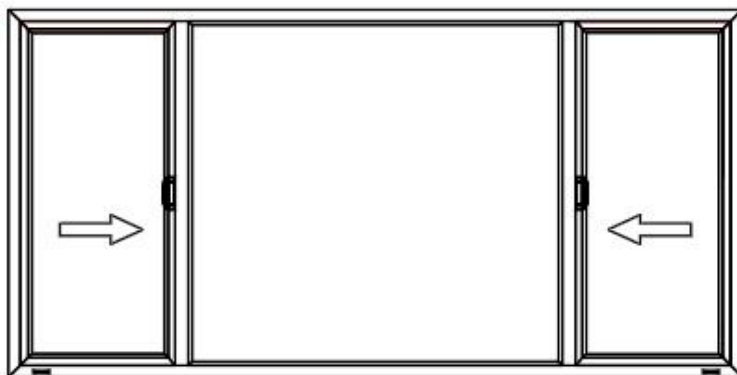

IM-OXOB3
Sliding from Center to Left Side
with three pictures from outside
(Look from Outside)

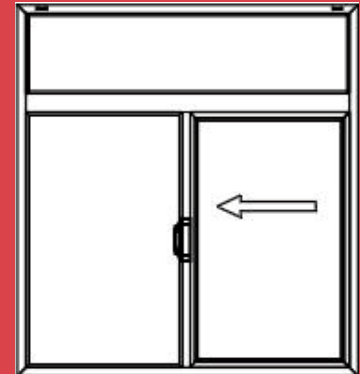

IM-OXB
Sliding from Right to Left
with one picture at top
(Look from Outside)

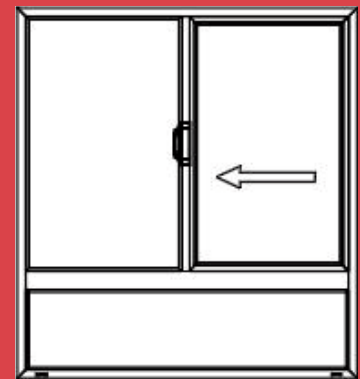

IM-OXB
Sliding from Right to Left
with one picture at bottom
(Look from Outside)

SINGLE HUNG WINDOWS

Single Hung windows open vertically and do not take up much space in the home. This makes them perfect for walkways, porches, patios or other places where you wouldn't want a window to protrude. They raise from the bottom for ventilation and when closed, provides superior structural integrity & resistance to wind.

The lower sash can be easily removed to clean the exterior glass from inside your home. Vertical sliding windows glide open with little effort & are faster to open than crank-style awning or casement windows.

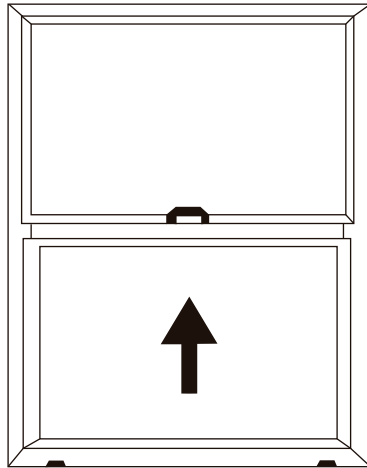

IM-SH

Single Hung

Push up from bottom
(Look from Outside)

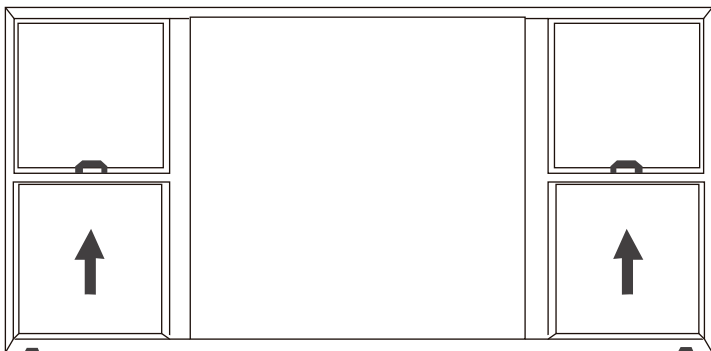

IM-SHOSH

Sidelites Single Hung
Push up from bottom
(Look from Outside)

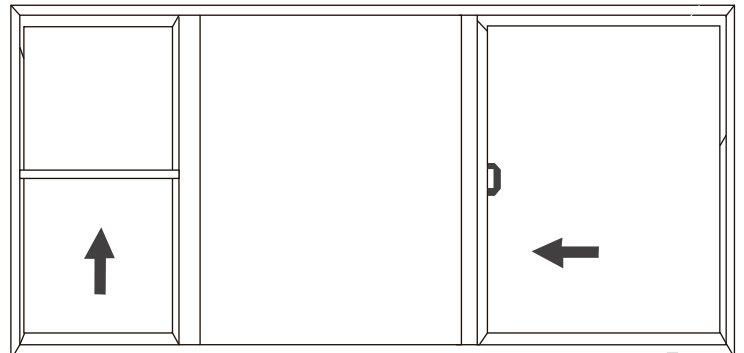

Sliding Single Hung

Special Link SH and XO
Up and Down
(Look from Outside)

CASEMENT & AWNING WINDOWS

These types of windows are hinged on either side so that the sash opens outward; from the top, to the right, or to the left, in a swinging motion. Casement & awning windows open and close with the turn of a hand crank, so they're great for spots that are difficult to reach- like behind furniture or over the kitchen sink. They are designed contemporary in style, allowing more light to enter the window, while also providing a larger view. Both compliment the simplicity of modern design and offer increased ventilation by opening up the entire glass area. Casement and awning windows can be assembled in the following variations:

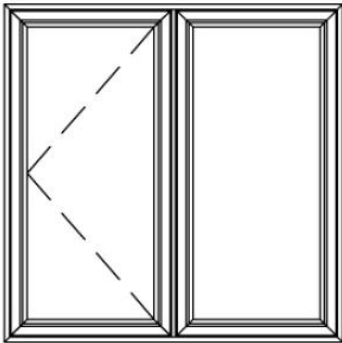

LXCM-XO
Single Opening with
Picture Casement Window
(Opening at Left)

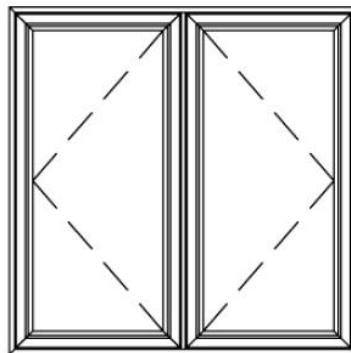

LXCM-XX
Double Opening
Casement Window

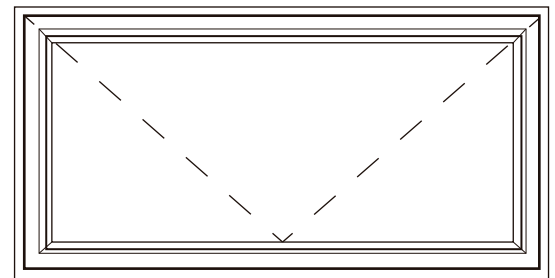

Awning Window
(Look from Outside)



The flip switch style operation allows for easy opening and closing. When in the locked position, you can rest assured you and your home are safe.

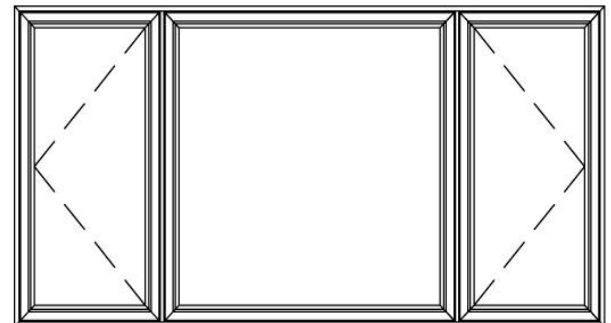

LXCM-XOX
XOX Double Sidelites Opening
Casement Window



All our casement and awning windows are assembled with heavy duty hinges & arms. These are extremely durable & make opening & closing windows a breeze. These hand cranks are designed so that when they are not in use, they are easily positioned back into a streamline shape.

SLIDING PATIO DOORS

Our sliding patio doors are engineered to operate with ease. Their heavy duty construction & hardware allows for even the largest size door to glide open with little effort. Our patio doors are sleek & less obtrusive than most designs available on the market today. The two-point lock system is made to withstand great force to keep you and your home safe and secure. You can add your personal touch by adding decorative glass, grid pattern or color. Below are the configurations for both the sliding patio door and French sliding door.



Sliding Patio Doors

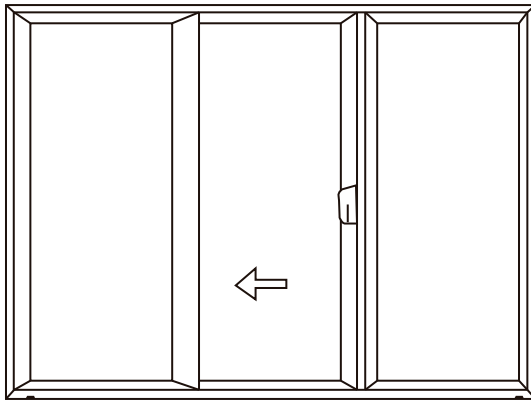

OXOL

Slide From Center to Left Side.

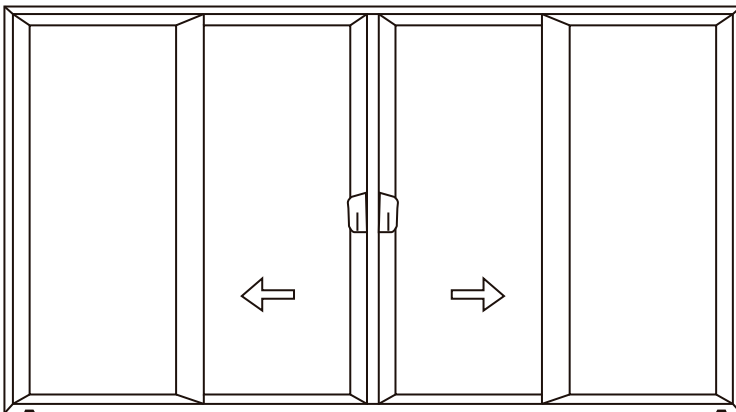

OXXO

Sliding From Center to Sidelites.



High precision, slide adjust rollers with composite wheels make opening & closing your doors a breeze!

Standard Handle



Interior View



Exterior View

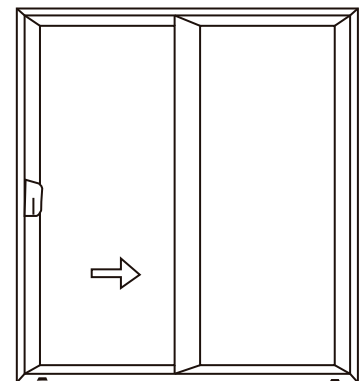

XO

From Left to Right Side.

FRENCH SWING DOORS

The Roger's Windows System hinged door design is offered as a single sash creating a beautiful main entrance or as a dual sash, also referred to as French doors, connecting the indoors with the outdoors. This versatile door system can be used for patio, deck or balcony access and is a popular choice among designers as an attractive alternative to sliding doors.

Compression-seal Technology

When the wind is blowing strong, the sash is pushed against the compression seals optimizing the air and water performance of the door. This door qualifies for coastal applications even in hurricane-prone areas. Multi-point locking hardware assures consistent compression on the seals all around the perimeter of the sash and frame.

Low Maintenance

Only occasional cleaning with soap and water is needed to keep the surfaces looking like new, even years after installation. Heavy-duty hinges have passed cycle testing of up to 100,00 opening and closing cycles without any need for adjustments.



French Swing Doors



LXFD-XR
Single French Door.

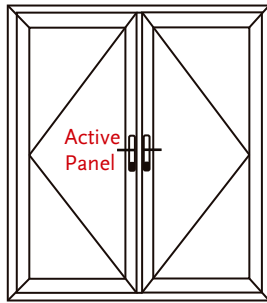

LXFD-XXL
Double Opening
French Door.

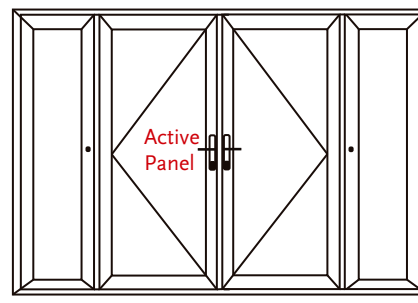

LXFD-OXXOL
Double Opening French Door
With Sidelites fixed.

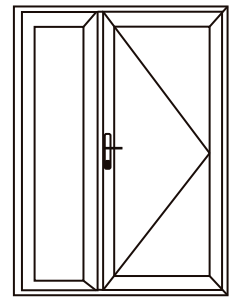

LXFD-OXRS
Single Opening French
Door With Fixed.

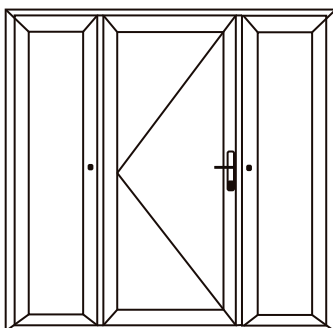

LXFD-OXOL
Single French Door With
Sidelites Fixed.

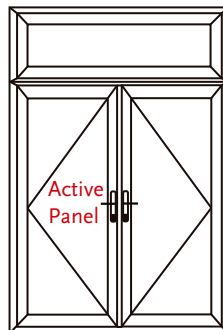

LXFD-XXTL
Double Opening French
Door With Top Picture.

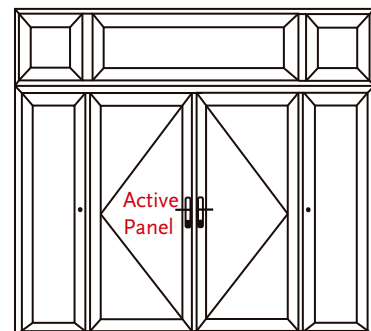

LXFD-OXXOTL
Double Opening With Sidelites Fixed
Swing Door, w/ Picture at Top.

BAY & BOW WINDOWS

With Bay & Bow Windows, you can create a new dimension to your living space. Bay windows are created by joining three windows together, generally the center window is fixed with fully operational single-hung or casement windows angled on either side. High-quality headboards and seat boards provide superior performance and durability. Bow windows consist of four or more windows joined together to form graceful curve. It's an elegant way to broaden your view and allows for lots of ventilation. We offer plenty of variation of both styles of windows.

BAY WINDOWS

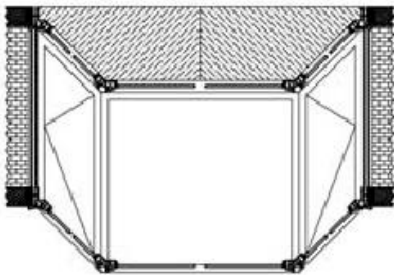

LXBAY-CM45

Luxury Frame Bay Window
with Casement
with 45° Mullions

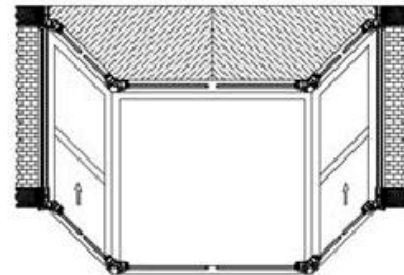

LXBAY-SH45

Luxury Frame Bay Window
with Single Hung
with 45° Mullions

BOW WINDOWS

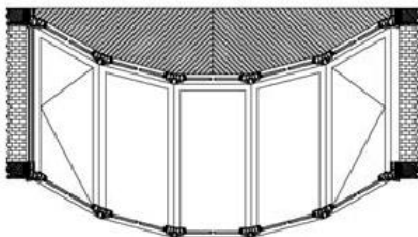

LXBOW-CM5S

Luxury Frame 5 Segments Bow Window
with Casement
with 15° Mullions

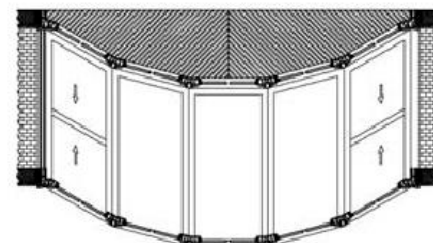

LXBOW-HDT5S

Luxury Frame 5 Segments Bow Window
with Double Hung Tilt
with 15° Mullions

GARDEN WINDOWS

Garden windows extend out from the house and generally have side vents and “an interior shelf which is perfect for plants or herbs. Our flexible design includes single hung side vents which open easily for ventilation. The window joints are designed to give maximum stability to withstand weight while still looking seamless. The bottom shelf provides a barrier against extreme temperatures which will protect your home from the heat or cold. Garden windows will also give the appearance of a larger room inside your house.

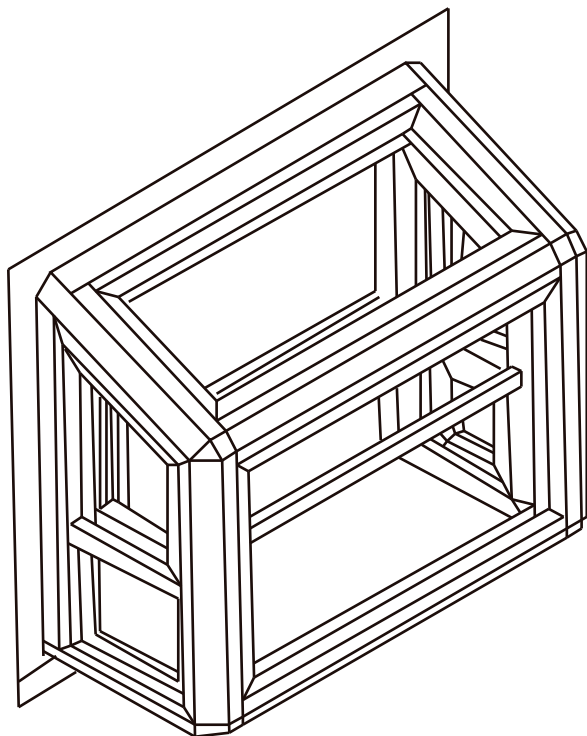

GARDEN WINDOW SPECIFICATIONS:

- Single Hung Side Vents
- One Adjustable Shelf
- White
- No Grid Options Available

SELECT YOUR GLASS

2

Roger's Windows offers many glass options. Whatever your climate, we make it easy for you to choose the perfect glass for your home. The standard glass we offer is LoE²-270, or you can upgrade to LoE-366. You also have the choice of gray or bronze tinted glass and diffused glass. We have several styles to choose from and can match any diffused glass pattern on the market today.

Why upgrade to LoE-366?



Cardinal Glass Industries Inc. introduces the ultimate performance glass, LoE-366. LoE-366 provides the highest levels of year-round comfort and energy savings, for all climates. The secret? A triple layer of silver coating on the glass. This will protect your furniture, carpet, curtains and fabrics in the home as well as keep the heat and cold weather out. Energy-efficient windows will save you a bundle and help the environment at the same time.

LOW-E Coating Performance

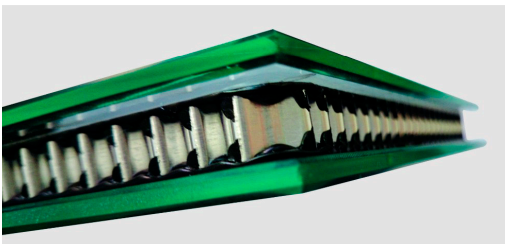
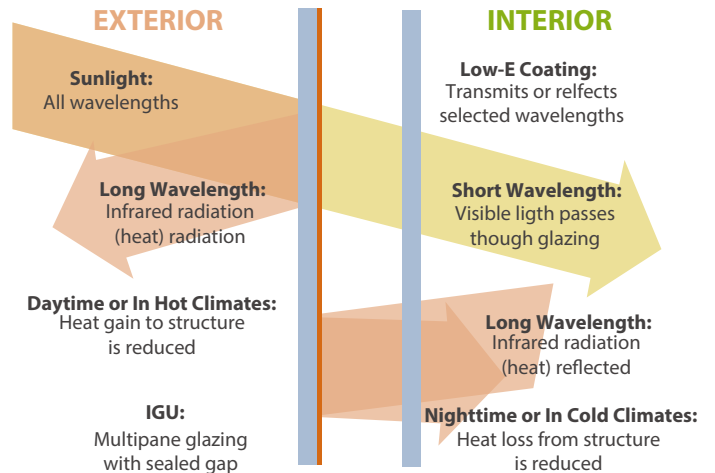

Duralite® Spacer is the technology inside our Windows & Doors



Truseal is a cost-effective system offering superior thermal efficiency. Truseal insulates the frame & edge of glass 90% better aluminum spacer bars.



Rain

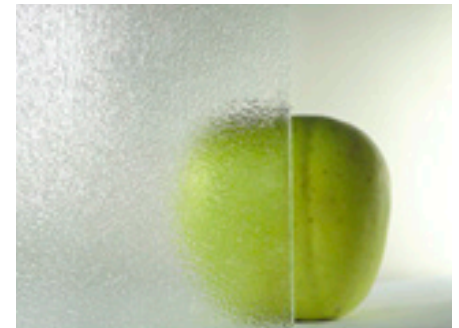

Obscure



Glue Chip



Bamboo

3

PERSONALIZE WITH DECORATIVE GRIDS

Roger's Windows offers the unique look of grids to almost all of our windows. These pieces are aluminum and are permanently sealed between panes of insulating glass, which creates a smooth surface that is easy to clean. We have many different layouts to choose from. We offer 1" flat grids, or 3/4" sculpture grids to create a polished look. Grids are available in white only.

1" Sculpture



3/4" Flat

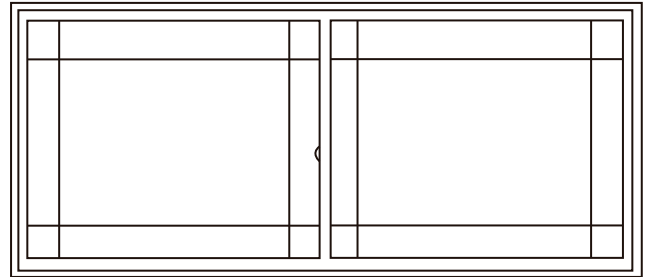

9- Lite Prairie

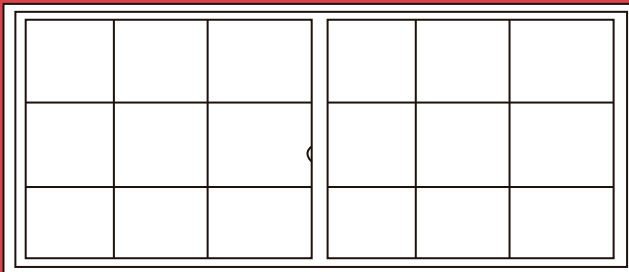

Colonial
(Look from Outside)

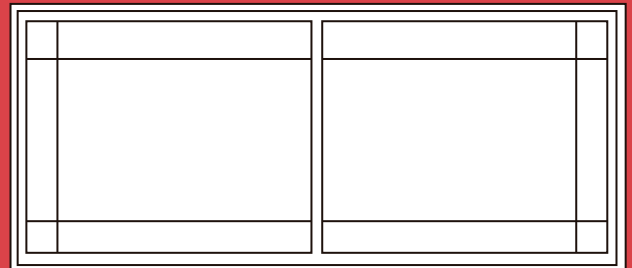

6- Lite Prairie
(Look from Outside)

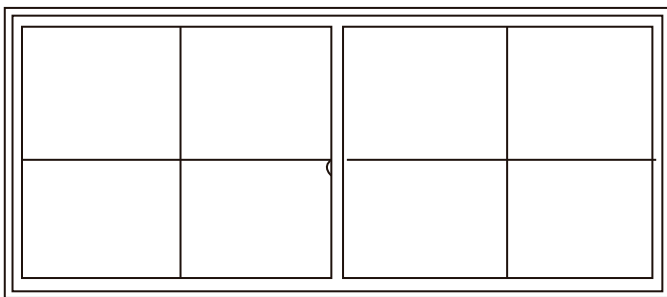

Custom (Equally Divided)
Additional patterns available

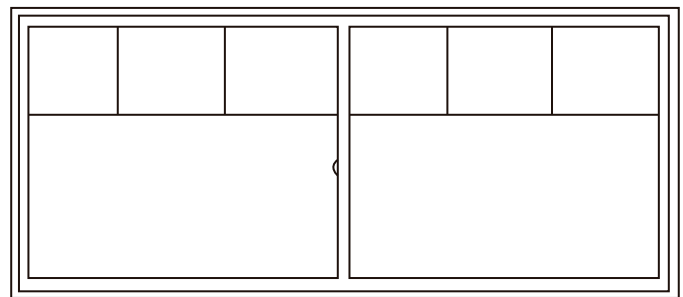

Victorian



ROGER'S WINDOWS GLASS & DOORS

www.rogerswindows.la

 [RogerWindows.la](https://www.instagram.com/RogerWindows.la)

 [Rogers WindowsGlass & Doors](https://www.facebook.com/RogersWindowsGlass&Doors)

 10464 Alondra Blvd, Bellflower, CA 90706

 (562) 866-5600

 8512 S. Comptom ave, Los Angeles, CA 90001

 (323) 584-9026